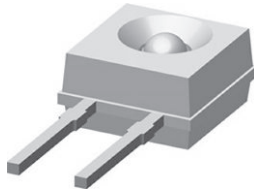


Infrared Emitting Diode, 950 nm, GaAs



14354

DESCRIPTION

The TSKS5400S is an infrared, 950 nm emitting diode in GaAs technology with high radiant power, molded in a clear plastic package.

FEATURES

- Package type: leaded
- Package form: side view lens
- Dimensions (L x W x H in mm): 5 x 2.65 x 5
- Peak wavelength: $\lambda_p = 950$ nm
- High reliability
- High radiant power
- High radiant intensity
- Angle of half intensity: $\phi = \pm 30^\circ$
- Low forward voltage
- Suitable for high pulse current operation
- Good spectral matching with Si photodetectors
- Package matched with detector TEKS5400
- Compliant to RoHS Directive 2002/95/EC and in accordance to WEEE 2002/96/EC



Note

** Please see document "Vishay Material Category Policy": www.vishay.com/doc?99902

APPLICATIONS

- Photointerrupters
- Transmissive sensors, gap sensors
- Reflective sensors

| PRODUCT SUMMARY | | | | |
|-----------------|---------------|--------------|------------------|------------|
| COMPONENT | I_e (mW/sr) | ϕ (deg) | λ_p (nm) | t_r (ns) |
| TSKS5400S | 4.5 | ± 30 | 950 | 800 |

Note

- Test conditions see table "Basic Characteristics"

| ORDERING INFORMATION | | | |
|----------------------|-----------|------------------------------|----------------|
| ORDERING CODE | PACKAGING | REMARKS | PACKAGE FORM |
| TSKS5400S | Bulk | MOQ: 2000 pcs, 2000 pcs/bulk | Side view lens |

Note

- MOQ: minimum order quantity

| ABSOLUTE MAXIMUM RATINGS ($T_{amb} = 25^\circ\text{C}$, unless otherwise specified) | | | | |
|---|--|------------|---------------|------------------|
| PARAMETER | TEST CONDITION | SYMBOL | VALUE | UNIT |
| Reverse voltage | | V_R | 6 | V |
| Forward current | | I_F | 100 | mA |
| Surge forward current | $t_p \leq 100 \mu\text{s}$ | I_{FSM} | 2 | A |
| Power dissipation | | P_V | 170 | mW |
| Junction temperature | | T_J | 100 | $^\circ\text{C}$ |
| Operating temperature range | | T_{amb} | - 25 to + 85 | $^\circ\text{C}$ |
| Storage temperature range | | T_{stg} | - 40 to + 100 | $^\circ\text{C}$ |
| Soldering temperature | $t \leq 5$ s, 2 mm from case | T_{sd} | 260 | $^\circ\text{C}$ |
| Thermal resistance junction/ambient | J-STD-051, leads 7 mm, soldered on PCB | R_{thJA} | 270 | K/W |

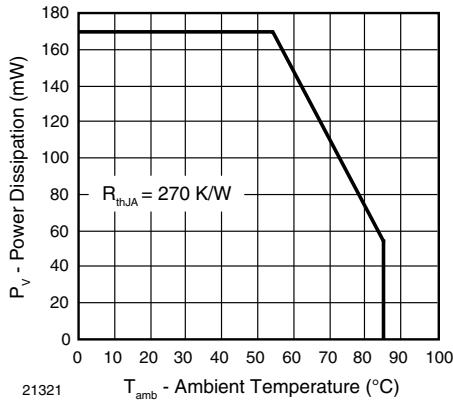


Fig. 1 - Power Dissipation Limit vs. Ambient Temperature

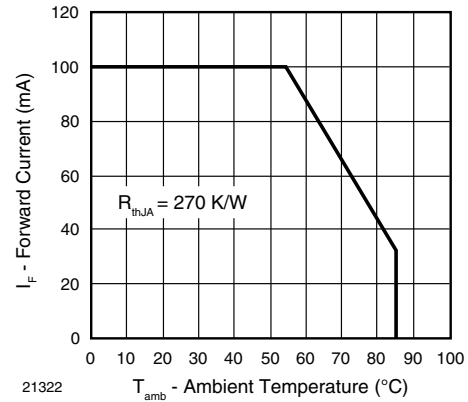


Fig. 2 - Forward Current Limit vs. Ambient Temperature

| BASIC CHARACTERISTICS ($T_{amb} = 25\text{ }^{\circ}\text{C}$, unless otherwise specified) | | | | | | |
|---|--|-----------------|------|----------|------|-------|
| PARAMETER | TEST CONDITION | SYMBOL | MIN. | TYP. | MAX. | UNIT |
| Forward voltage | $I_F = 100\text{ mA}$, $t_p \leq 20\text{ ms}$ | V_F | | 1.3 | 1.7 | V |
| Reverse voltage | $I_R = 10\text{ }\mu\text{A}$ | V_R | 6 | | | V |
| Temperature coefficient of V_F | $I_F = 100\text{ mA}$ | TK_{V_F} | | -1.3 | | mV/K |
| Junction capacitance | $V_R = 0\text{ V}$, $f = 1\text{ MHz}$, $E = 0$ | C_j | | 50 | | pF |
| Radiant intensity | $I_F = 100\text{ mA}$, $t_p \leq 20\text{ ms}$ | I_e | 2 | 4.5 | 7 | mW/sr |
| Radiant power | $I_F = 50\text{ mA}$, $t_p \leq 20\text{ ms}$ | ϕ_e | | 10 | | mW |
| Temperature coefficient of ϕ_e | $I_F = 50\text{ mA}$ | TK_{ϕ_e} | | -1.0 | | %/K |
| Angle of half sensitivity | | ϕ | | ± 30 | | deg |
| Peak wavelength | $I_F = 50\text{ mA}$ | λ_p | | 950 | | nm |
| Spectral bandwidth | $I_F = 50\text{ mA}$ | $\Delta\lambda$ | | 50 | | nm |
| Rise time | $I_F = 100\text{ mA}$ | t_r | | 800 | | ns |
| | $I_F = 1\text{ A}$, $t_p/T = 0.01$, $t_p \leq 10\text{ }\mu\text{s}$ | t_r | | 450 | | ns |

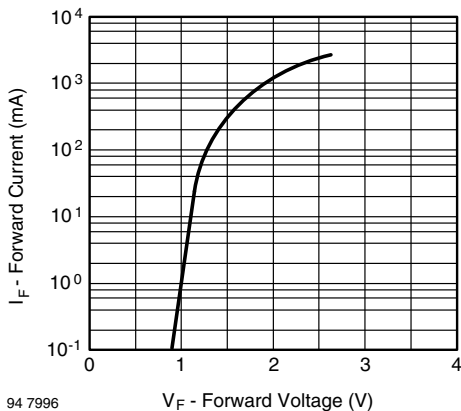
BASIC CHARACTERISTICS ($T_{amb} = 25\text{ }^{\circ}\text{C}$, unless otherwise specified)


Fig. 3 - Pulse Forward Current vs. Forward Voltage

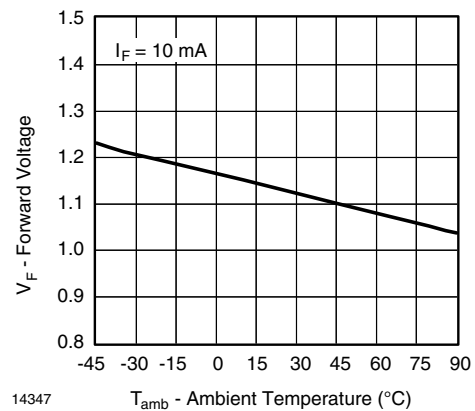
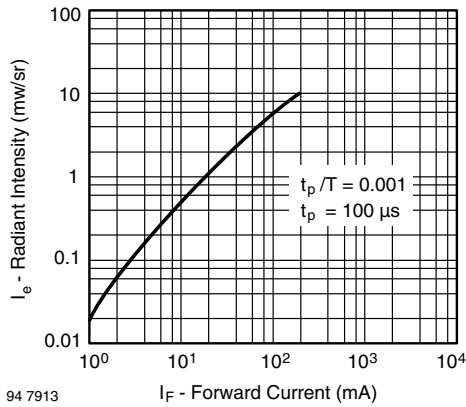
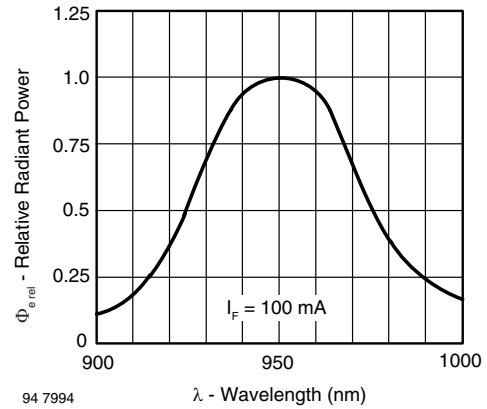


Fig. 4 - Forward Voltage vs. Ambient Temperature



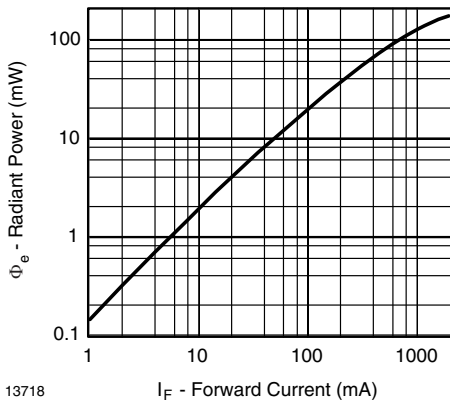
94 7913

Fig. 5 - Radiant Intensity vs. Forward Current



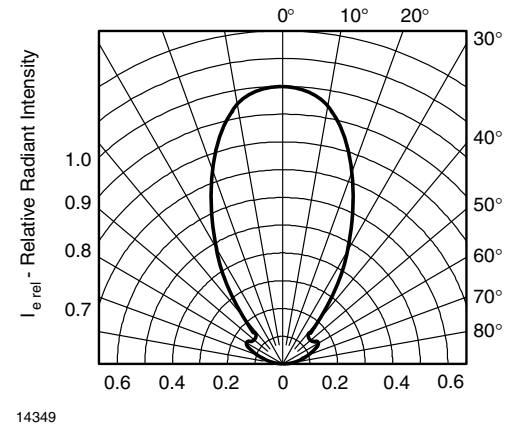
94 7994

Fig. 8 - Relative Radiant Power vs. Wavelength



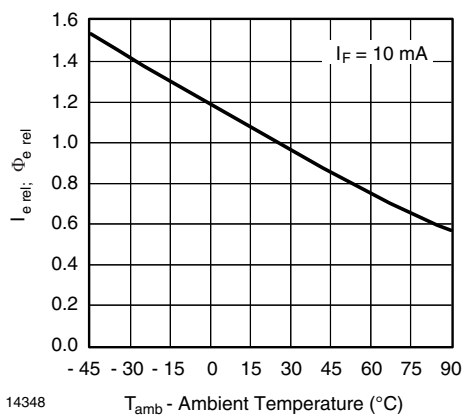
13718

Fig. 6 - Radiant Power vs. Forward Current



14349

Fig. 9 - Relative Radiant Intensity vs. Angular Displacement

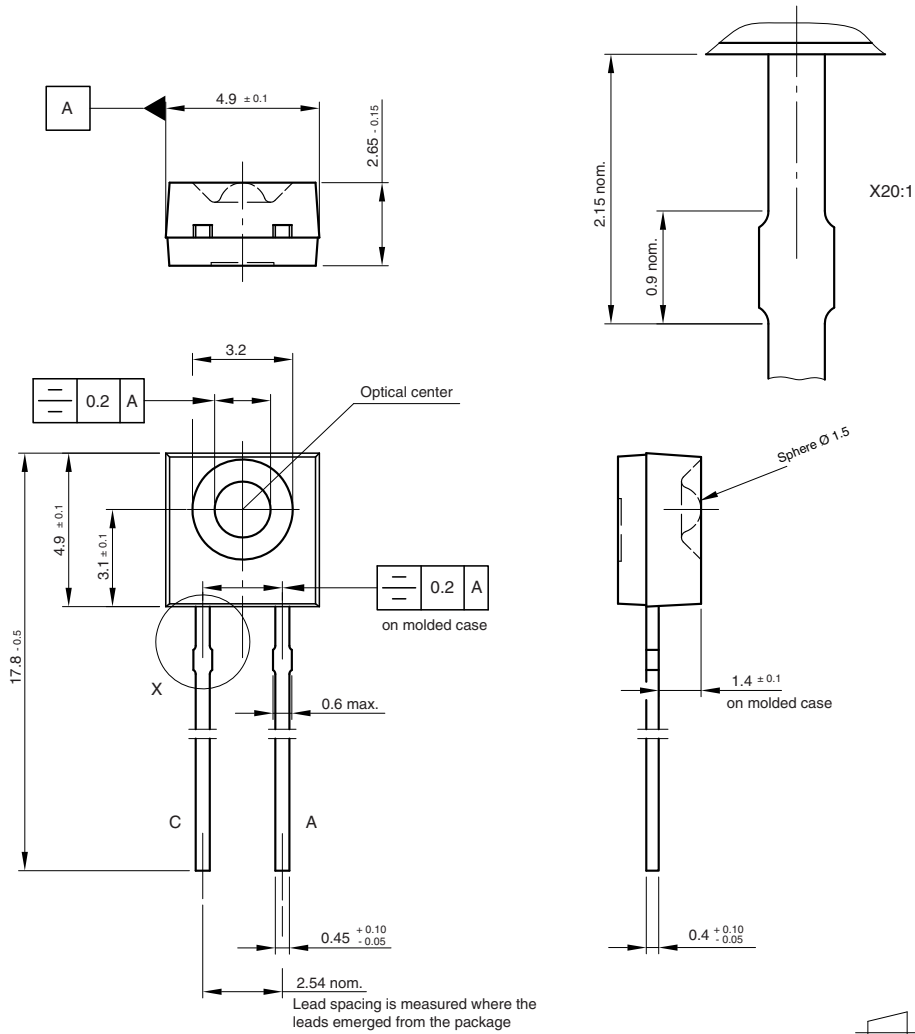


14348

Fig. 7 - Relative Radiant Intensity vs. Ambient Temperature

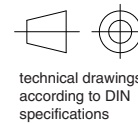


PACKAGE DIMENSIONS in millimeters



Protruded resin area where the leads emerged from the package 0.8 max.

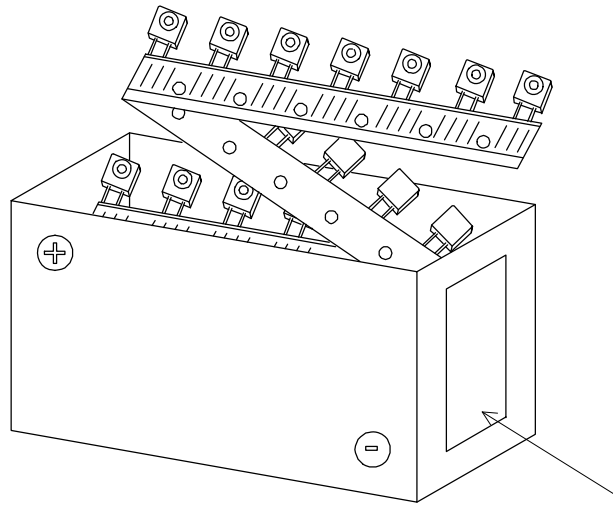
Drawing-No.: 6.544-5306.51-4
Issue: 6; 04.07.02
14307



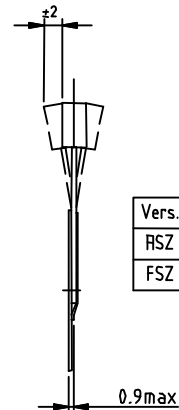
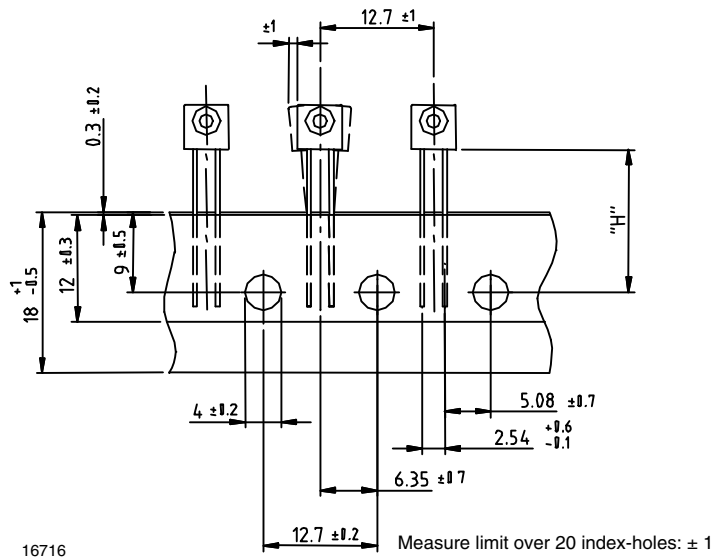
technical drawings according to DIN specifications



TAPE AND AMMOPACK STANDARDS DIMENSIONS in millimeters



Labeling: barcode-label see 5.6.4



| Vers. | Dim. "H" |
|-------|----------|
| RSZ | 16 ±0.5 |
| FSZ | 27 ±0.5 |



Disclaimer

ALL PRODUCT, PRODUCT SPECIFICATIONS AND DATA ARE SUBJECT TO CHANGE WITHOUT NOTICE TO IMPROVE RELIABILITY, FUNCTION OR DESIGN OR OTHERWISE.

Vishay Intertechnology, Inc., its affiliates, agents, and employees, and all persons acting on its or their behalf (collectively, "Vishay"), disclaim any and all liability for any errors, inaccuracies or incompleteness contained in any datasheet or in any other disclosure relating to any product.

Vishay makes no warranty, representation or guarantee regarding the suitability of the products for any particular purpose or the continuing production of any product. To the maximum extent permitted by applicable law, Vishay disclaims (i) any and all liability arising out of the application or use of any product, (ii) any and all liability, including without limitation special, consequential or incidental damages, and (iii) any and all implied warranties, including warranties of fitness for particular purpose, non-infringement and merchantability.

Statements regarding the suitability of products for certain types of applications are based on Vishay's knowledge of typical requirements that are often placed on Vishay products in generic applications. Such statements are not binding statements about the suitability of products for a particular application. It is the customer's responsibility to validate that a particular product with the properties described in the product specification is suitable for use in a particular application. Parameters provided in datasheets and/or specifications may vary in different applications and performance may vary over time. All operating parameters, including typical parameters, must be validated for each customer application by the customer's technical experts. Product specifications do not expand or otherwise modify Vishay's terms and conditions of purchase, including but not limited to the warranty expressed therein.

Except as expressly indicated in writing, Vishay products are not designed for use in medical, life-saving, or life-sustaining applications or for any other application in which the failure of the Vishay product could result in personal injury or death. Customers using or selling Vishay products not expressly indicated for use in such applications do so at their own risk and agree to fully indemnify and hold Vishay and its distributors harmless from and against any and all claims, liabilities, expenses and damages arising or resulting in connection with such use or sale, including attorneys fees, even if such claim alleges that Vishay or its distributor was negligent regarding the design or manufacture of the part. Please contact authorized Vishay personnel to obtain written terms and conditions regarding products designed for such applications.

No license, express or implied, by estoppel or otherwise, to any intellectual property rights is granted by this document or by any conduct of Vishay. Product names and markings noted herein may be trademarks of their respective owners.